

MINI SPOP/WASH MOVING HEAD USER MANUAL

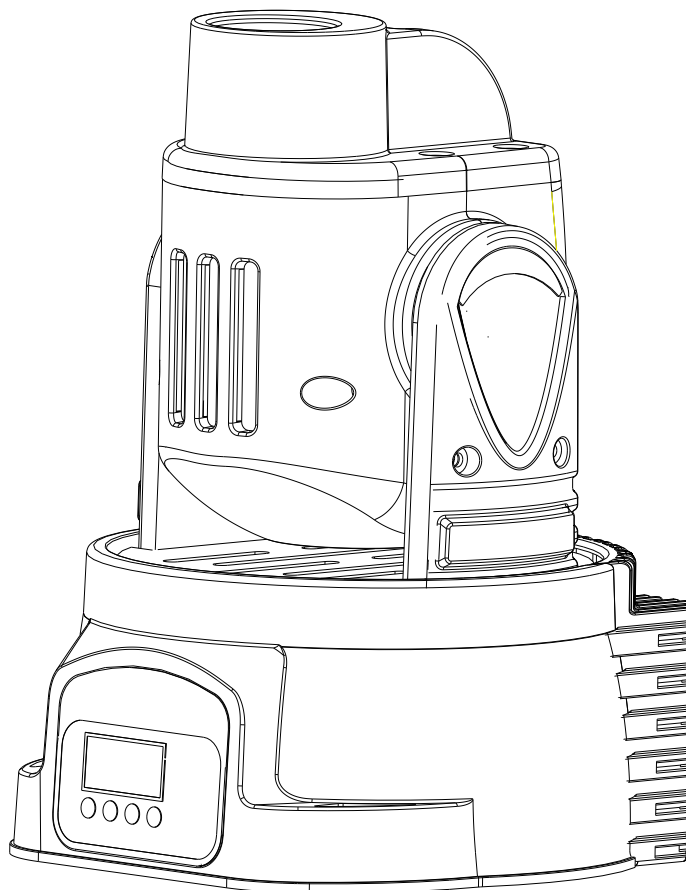

TABLE OF CONTENTS

1. BEFORE YOU BEGIN.....	3
WHAT IS INCLUDED.....	3
UNPACKING INSTRUCTIONS	3
AC POWER.....	3
SAFETY INSTRUCTIONS.....	4
2. INTRODUCTION	5
FEATURES.....	5
DMX CHANNEL SUMMARY 13 CHANNEL MODE FOR SPOT.....	5
DMX CHANNEL SUMMARY 12 CHANNEL MODE FOR WASH.....	5
DMX CHANNEL SUMMARY 5 CHANNEL MODE FOR SPOT.....	6
DMX CHANNEL SUMMARY 4 CHANNEL MODE FOR WASH.....	6
PRODUCT OVERVIEW.....	6
3. SETUP	7
FUSE REPLACEMENT.....	7
FIXTURE LINKING	7
Data Cabling	7
DMX Data Cable.....	7
Cable Connectors	8
3-Pin to 5-Pin Conversion Chart	8
SETTING UP ADMX SERIAL DATA LINK.....	8
MASTER/SLAVE FIXTURE LINKING.....	9
MOUNTING	9
Orientation	9
Rigging	9
4. OPERATING INSTRUCTIONS.....	10
NAVIGATING THE CONTROL PANEL	10
MENU MAP.....	11
USER CONFIGURATIONS	11
USER CONFIGURATIONS	12
To set the pan to inverting or non-inverting:	12
To set the tilt to inverting or non-inverting:.....	12
To set the LED Readout to Inverting or Non-Inverting:	12
To set the DMX channel configuration:.....	12
To set the maximum pan angle:	12
To set the maximum tilt angle:	12
Service Functions	12
To reset the fixture:.....	12
To restore all settings to their factory defaults:	12
OPERATION.....	13
Stand-Alone Mode (Sound-Active, Auto Mode):	13
Master/Slave Mode (Master Sound, Master Auto):	13
DMX Mode	13
DMX CHANNEL VALUES (13 CHANNEL FOR SPOT)	14
DMX CHANNEL VALUES (12 CHANNEL FOR WASH).....	15
DMX CHANNEL VALUES (5 CHANNEL FOR SPOT)	16
DMX CHANNEL VALUES (4 CHANNEL FOR WASH).....	16
5. APPENDIX.....	17
TECHNICAL SPECIFICATIONS	17

1. BEFORE YOU BEGIN

What is included

1 x Mini Spot/wash
User Manual

Unpacking Instructions

Immediately upon receiving a fixture, carefully unpack the carton, check the contents to ensure that all parts are present, and have been received in good condition. Notify the shipper immediately and retain packing material for inspection if any parts appear damaged from shipping or the carton itself shows signs of mishandling. Save the carton and all packing materials. In the event that a fixture must be returned to the factory, it is important that the fixture be returned in the original factory box and packing.

AC Power

To determine the power requirements for a particular fixture, see the label affixed to the back plate of the fixture or refer to the fixture's specifications chart. A fixture's listed current rating is its average current draw under normal conditions. All fixtures must be powered directly off a switched circuit and cannot be run off a rheostat (variable resistor) or dimmer circuit, even if the rheostat or dimmer channel is used solely for a 0% to 100% switch. Before applying power to a fixture, check that the source voltage matches the fixture's requirement. Check the fixture or device carefully to make sure that if a voltage selection switch exists that it is set to the correct line voltage you will use.

Figure 1 - AC Voltage Switch

Warning! Verify that the voltage select switch on your unit matches the line voltage applied. Damage to your fixture may result if the line voltage applied does not match the voltage indicated on the voltage selector switch. All fixtures must be connected to circuits with a suitable Earth Ground.



Not all fixtures have a voltage select switch. Please be sure to connect to the proper voltage.

Safety Instructions

Please read these instructions carefully, it includes important information about the installation, usage and maintenance of this product.

- Please keep this User Guide for future consultation. If you sell the unit to another user, be sure that they also receive this instruction booklet.
- Always make sure that you are connecting to the proper voltage, and that the line voltage you are connecting to is not higher than that stated on the decal or rear panel of the fixture.
- This product is intended for indoor use only!
- To prevent risk of fire or shock, do not expose fixture to rain or moisture. Make sure there are no flammable materials close to the unit while operating.
- The unit must be installed in a location with adequate ventilation, at least 20in (50cm) from adjacent surfaces. Be sure that no ventilation slots are blocked.
- Always disconnect from power source before servicing or replacing fuse and be sure to replace with same fuse size and type.
- Secure fixture to fastening device using a safety chain. Never carry the fixture solely by its head. Use its carrying handles.
- Maximum ambient temperature (Ta) is 104° F (40° C). Do not operate fixture at temperatures higher than this.
- In the event of a serious operating problem, stop using the unit immediately. Never try to repair the unit by yourself. Repairs carried out by unskilled people can lead to damage or malfunction. Please contact the nearest authorized technical assistance center. Always use the same type spare parts.
- Don't connect the device to a dimmer pack.
- Make sure the power cord is never crimped or damaged.
- Never disconnect the power cord by pulling or tugging on the cord.
- Avoid direct eye exposure to the light source while it is on.

2. INTRODUCTION

Features

CONTROL FEATURES

- 5 or 13-channel DMX-512 LED moving yoke
- Pan: 540° / tilt: 270°
- RGB color mixing
- Gobo wheel
 - 9 gobos + open
 - Gobo wheel spin effect
- Variable electronic strobe
- Variable electronic dimmer (0 - 100%)
- Vector speed channel for pan/tilt, RGB color mixing and color macros
- Built-in movement macros via master/slave or DMX

ADDITIONAL FEATURES

- User-selectable basic or advanced operating modes
- User-selectable pan/tilt ranges
 - Pan: 540° , 360° , 180°
 - Tilt: 270° , 180° , 90°
- Compact and lightweight
- LED display menu with invert
- Reset to factory settings option
- Display auto on/off
- Pan/tilt invert option
- Fan cooled

OPTIONAL CONTROLLERS

- Easy Controller (CA-9)

DMX Channel Summary - 13 Channel Mode for Spot - 12 Channel Mode for Wash

CHANNEL	FUNCTION	CHANNEL	FUNCTION
1	Pan	1	Pan
2	Pan Fine	2	Pan Fine
3	Tilt	3	Tilt
4	Tilt Fine	4	Tilt Fine
5	Vector Speed (Pan/Tilt)	5	Vector Speed (Pan/Tilt)
6	Dimmer/Strobe	6	Dimmer/Strobe
7	Red	7	Red
8	Green	8	Green
9	Blue	9	Blue
10	Color Macros	10	Color Macros
11	Vector Speed (Color)	11	Vector Speed (Color)
12	Movement Macros	12	Movement Macros
13	Gobo		

DMX Channel Summary - 5 Channel Mode for Spot - 4 Channel Mode for Wash

CHANNEL	FUNCTION
1	Pan
2	Tilt
3	Dimmer/Strobe
4	Color Macros
5	Gobo

CHANNEL	FUNCTION
1	Pan
2	Tilt
3	Dimmer/Strobe
4	Color Macros

Product Overview

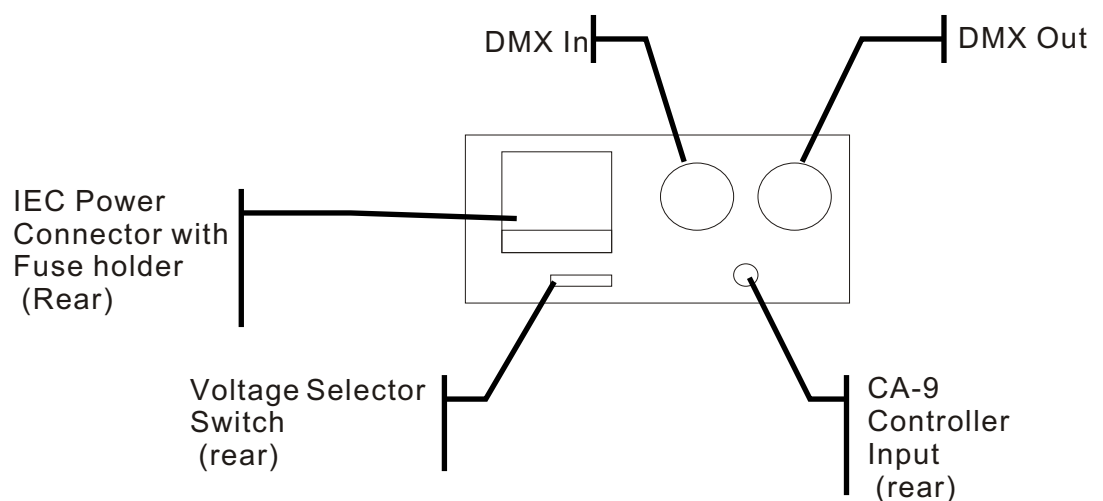
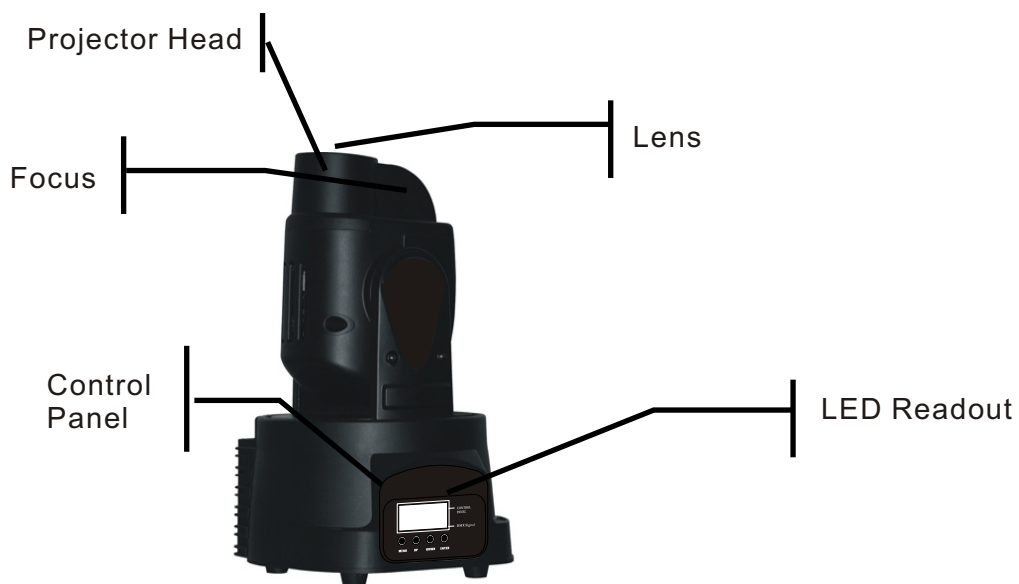

3. SETUP



Disconnect the powercord before replacing a fuse and always replace with the same type fuse.



Fuse Replacement

With a flat head screwdriver wedge the fuse holder out of its housing. Remove the damaged fuse from its holder and replace with exact same type fuse. Insert the fuse holder back in its place and reconnect power.

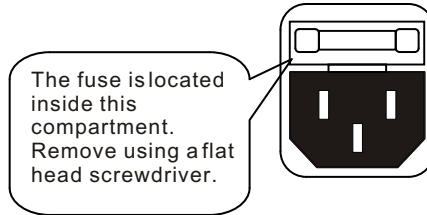

Fixture Linking

You will need a serial data link to run light shows of one or more fixtures using a DMX-512 controller or to run synchronized shows on two or more fixtures set to a master/slave operating mode. The combined number of channels required by all the fixtures on a serial data link determines the number of fixtures the data link can support.

Important: Fixtures on a serial data link must be daisy chained in one single line. To comply with the EIA-485 standard no more than 32 devices should be connected on one data link. Connecting more than 32 fixtures on one serial data link without the use of a DMX optically-isolated splitter may result in deterioration of the digital DMX signal.

Maximum recommended serial data link distance: 500 meters (1640 ft.)

Maximum recommended number of fixtures on a serial data link: 32 fixtures

Data Cabling

To link fixtures together you must obtain data cables. You can purchase CHAUVET-certified DMX cables directly from a dealer/distributor or construct your own cable. If you choose to create your own cable please use data-grade cables that can carry a high quality signal and are less prone to electromagnetic interference.

DMX DATA CABLE

Use a Belden? 9841 or equivalent cable which meets the specifications for EIA RS-485 applications. Standard microphone cables cannot transmit DMX data reliably over long distances. The cable will have the following characteristics:

2-conductor twisted pair plus a shield

Maximum capacitance between conductors - 30 pF/ft.

Maximum capacitance between conductor and shield - 55 pF/ft.

Maximum resistance of 20 ohms / 1000 ft.

Nominal impedance 100 - 140 ohms

CABLE CONNECTORS

Cabling must have a male XLR connector on one end and a female XLR connector on the other end.

DMX connector configuration

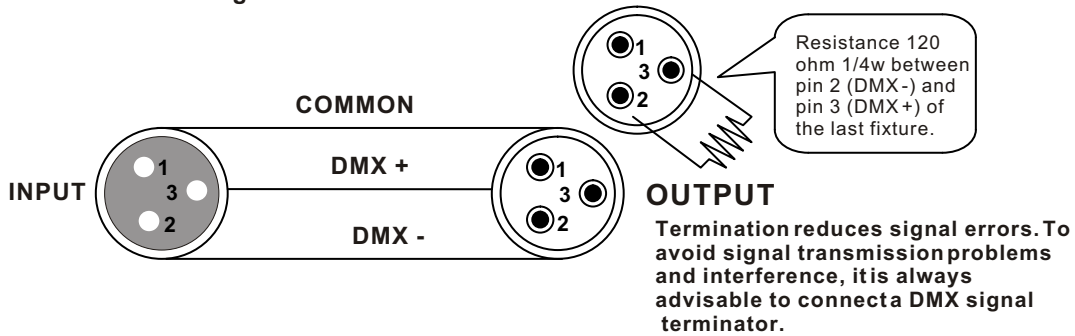

CAUTION Do not allow contact between the common and the fixture's chassis ground. Grounding the common can cause a ground loop, and your fixture may perform erratically. Test cables with an ohm meter to verify correct polarity and to make sure the pins are not grounded or shorted to the shield or each other.

3-PIN TO 5-PIN CONVERSION CHART

Note! If you use a controller with a 5 pin DMX output connector, you will need to use a 5 pin to 3 pin adapter. CHAUVET Model No: DMX5M, or DMX5F. The chart below details a proper cable conversion:

3 PIN TO 5 PIN CONVERSION CHART

Conductor	3 Pin Female (output)	5 Pin Male (Input)
Ground/Shield	Pin 1	Pin 1
Data (-) signal	Pin 2	Pin 2
Data (+) signal	Pin 3	Pin 3
Do not use		Do not use
Do not use		Do not use

Setting up a DMX Serial Data Link

1. Connect the (male) 3 pin connector side of the DMX cable to the output (female) 3 pin connector of the controller.
2. Connect the end of the cable coming from the controller which will have a (female) 3 pin connector to the input connector of the next fixture consisting of a (male) 3 pin connector.
3. Then, proceed to connect from the output as stated above to the input of the following fixture and so on.

DMX Data Cables

Order Code	Description
DMX1.5	DMX Cable 1.5m/4.9ft
DMX4.5	DMX Cable 4.5m/14.8ft
DMX10	DMX Cable 10m/32.8ft

Universal DMX Controller

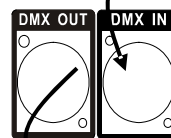
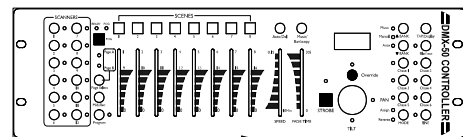

This drawing provides a general illustration of the DMX Input/Output panel of a lighting fixture

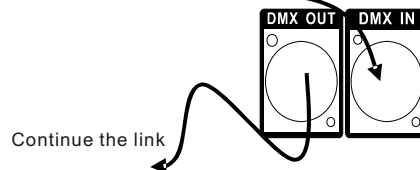

Master/Slave Fixture Linking

1. Connect the (male) 3 pin connector side of the DMX cable to the output (female) 3 pin connector of the first fixture.
2. Connect the end of the cable coming from the first fixture which will have a (female) 3 pin connector to the input connector of the next fixture consisting of a (male) 3 pin connector. Then, proceed to connect from the output as stated above to the input of the following fixture and so on

Often, the setup for Master-Slave and Standalone operation requires that the first fixture in the chain be initialized for this purpose via either settings in the control panel or DIP-r switches. Secondly, the fixtures that follow may also require a slave setting. Please consult the "Operating Instructions" section in this manual for complete instructions for this type of setup and configuration.

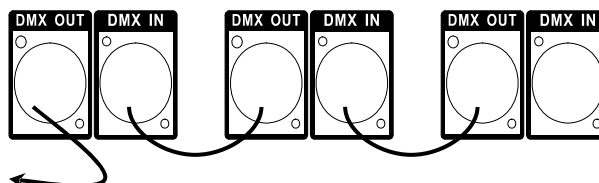

Mounting

ORIENTATION

This fixture may be mounted in any position provided there is adequate room for ventilation.

RIGGING

It is important never to obstruct the fan or vents pathway. Mount the fixture using, a suitable "C" or "O" type clamp. Adjust the angle of the fixture by loosening both knobs and tilting the fixture. After finding the desired position, retighten both knobs.

- When selecting installation location, take into consideration lamp replacement access and routine maintenance.
- Safety cables must always be used.
- Never mount in places where the fixture will be exposed to rain, high humidity, extreme temperature changes or restricted ventilation.

Hanging Clamp

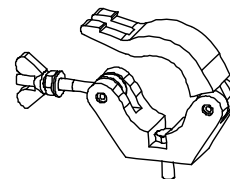

Note!
Clamp is sold separately.

4. OPERATING INSTRUCTIONS

Navigating the Control Panel

Access control panel functions using the four panel buttons located directly underneath the LCD Display.

Button	Function
<MODE/ESC>	Used to access the menu or to return to a previous menu option
<UP>	Scrolls through menu options in ascending order
<DOWN>	Scrolls through menu options in descending order
<ENTER>	Used to select and store the current menu or option within a menu

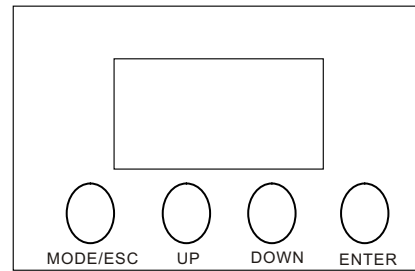

The Control Panel LED Display shows the menu items you select from the menu map on page #11. When a menu function is selected, the display will show immediately the first available option for the selected menu function. To select a menu item, press <ENTER>.

Press the <MODE/ESC> button repeatedly until you reach the desired menu function. Use the <UP> and <DOWN> buttons to navigate the menu options. Press the <ENTER> button to select the menu function currently displayed, or to enable a menu option. To return to the previous option or menu without changing the value, press the <MODE/ESC> button.

Menu Map

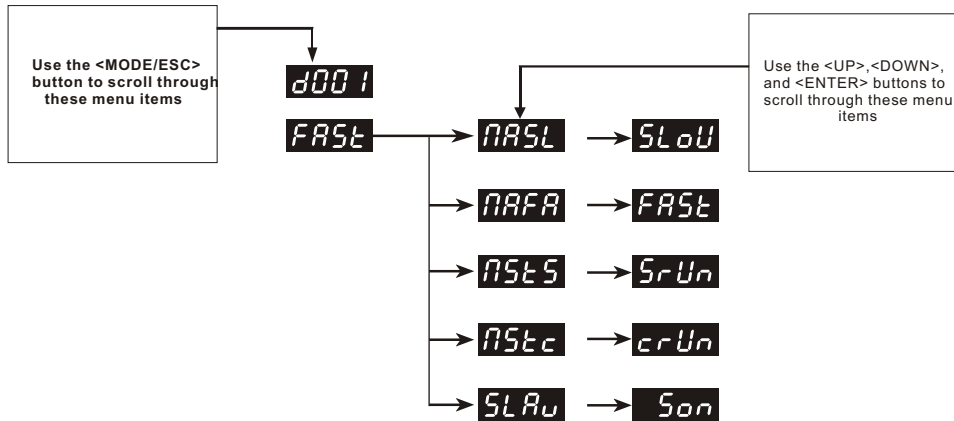

Use the <MODE/ESC> button to scroll through these menu items

Use the <UP>, <DOWN>, and <ENTER> buttons to scroll through these menu items

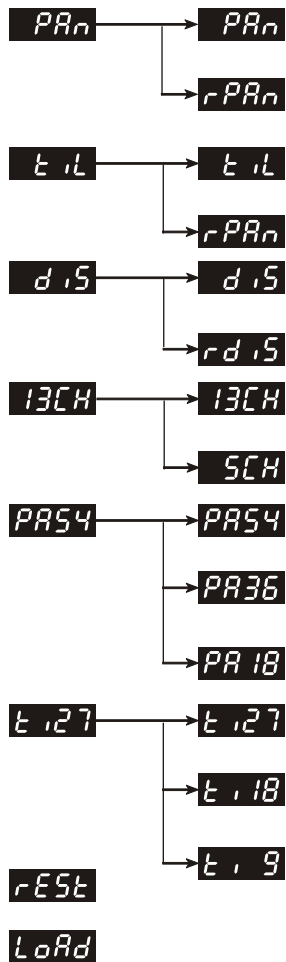

When navigating the menu:
 Use the "UP" button to move up.
 Use the "DOWN" button to move down.
 Use the "ENTER" button to move right.
 Use the "MODE" button to move left, or to scroll through the left-most items in the menu map.

User Configurations

TO SET THE PAN TO INVERTING OR NON- INVERTING:

- 1) Press the Mode button until it shows **PA_n** or **rPA_n**
- 2) Use the Up/Down buttons to set to the desired inversion, press enter to confirm.

TO SET THE TILT TO INVERTING OR NON- INVERTING:

- 1) Press the Mode button until it shows **t iL** or **rt iL**
- 2) Use the Up/Down buttons to set to the desired inversion, press enter to confirm.

TO SET THE LED READOUT TO INVERTING OR NON- INVERTING:

- 1) Press the Mode button until it shows **d iS** or **rd iS**
- 2) Use the Up/Down buttons to set to the desired inversion, press enter to confirm.

TO SET THE DMX CHANNEL CONFIGURATION:

- 1) Press the Mode button until it shows **13CH** or **5CH**
- 2) Use the Up/Down buttons to set to the desired inversion, press enter to confirm.

TO SET THE MAX I MUM PAN ANGLE:

- 1) Press the Mode button until it shows **PA54** or **PA36** or **PA 18**
- 2) Use the Up/Down buttons to set to the desired inversion, press enter to confirm.

TO SET THE MA X I MUM TILT ANGLE:

- 1) Press the Mode button until it shows **t 27** or **t 18** or **t 9**
- 2) Use the Up/Down buttons to set to the desired inversion, press enter to confirm.

Service Functions

TO RESET THE FIXTURE:

- 1) Press the Mode button until the display shows **rESt**
- 2) Press enter to confirm your selection.

TO RESTORE ALL SETTINGS TO THEIR FACTORY DEFAULTS:

- 1) Press the mode button until the display reads **LoAd**
- 2) Press enter to confirm your selection.

Operation

Stand-Alone Mode (Auto Mode):

This mode allows a single unit to run to a factory installed program in one of two speeds.

- 1) To set the fixture in auto mode Fast, select **NAFA**. Once confirmed the display reads **FAST**
- 2) To set the fixture in auto mode Slow, select **NASL**. Once confirmed the display reads **SLoU**

Master/Slave Mode (Master Sound):

This mode will allow you to link up to 32 units together without a controller.

- 1) Use standard DMX cables to daisy chain your units together via the DMX connector on the rear of the units. Proper performance it may be necessary to use a terminator at the last fixture. For more information about terminators, see page 8.
- 2) Choose a unit to function as the Master. Select NAFA/NASL or NStS (see below for readout) depending upon which master mode you require. The master unit must be the first unit in line. Finally, chain the units together using DMX cable.

Master Auto **NAFA** or **NASL**

Master Sound **NStS** becomes **SrUn** when confirmed

- 3) Select slave function by using the Up/Down keys to reach SLAv in the Master/Auto menu on the slave units, and they will react in the same as the Master.











Slave **SLAv** becomes **SoN** when confirmed

DMX Mode

This mode allows the unit to be controlled by any universal DMX controller. If you are unfamiliar with DMX, please read the DMX Primer on page #19.

- 1) The default mode for the fixture is DMX, which appears as **d001** on the LED Readout.











DMX Channel Values (13 Channel)

CHANNEL	VALUE	FUNCTION
1	000 ↔ 255	Pan
2	000 ↔ 255	Pan Fine
3	000 ↔ 255	Tilt
4	000 ↔ 255	Tilt Fine
5	000 ↔ 255	Vector Speed:(Normal → Slow)
6	000 ↔ 007	Dimmer/Strobe
	008 ↔ 134	Closed
	135 ↔ 239	100-0%
	240 ↔ 255	Strobe(slow → fast) Open
7	000 ↔ 255	Red
		0-100%
8	000 ↔ 255	Green
		0-100%
9	000 ↔ 255	Blue
		0-100%
10	Color Macros	
	000 ↔ 007	No Function
	008 ↔ 021	White
	022 ↔ 034	Red
	036 ↔ 049	Green
	050 ↔ 063	Blue
	064 ↔ 077	Cyan
	078 ↔ 091	Magenta
	092 ↔ 105	Yellow
	106 ↔ 119	Purple
	120 ↔ 133	Orange
	134 ↔ 147	Chartreuse
	148 ↔ 161	Pink
	162 ↔ 175	Brown
	176 ↔ 189	Gold
	190 ↔ 203	Crimson
	204 ↔ 217	Violet
218 ↔ 231	Crape	
232 ↔ 255	Color-Change Macro 1	
11	000 ↔ 255	Vector Speed(Color)
12	Movement Macros	
	000 ↔ 007	No Function
	008 ↔ 022	Auto Program 1
	023 ↔ 037	Auto Program 2
	038 ↔ 052	Auto Program 3
	053 ↔ 067	Auto Program 4
	068 ↔ 082	Auto Program 5
	083 ↔ 097	Auto Program 6
	098 ↔ 112	Auto Program 7
	113 ↔ 127	Auto Program 8
	128 ↔ 142	Sound Active 1
	143 ↔ 157	Sound Active 2
	158 ↔ 172	Sound Active 3
	173 ↔ 187	Sound Active 4
	188 ↔ 202	Sound Active 5
	203 ↔ 217	Sound Active 6
	218 ↔ 232	Sound Active 7
233 ↔ 255	Sound Active 8	
13	Gobo	
	0~7	
	8~15	
	16~23	
	24~31	
	32~39	
	40~47	
	48~55	
	56~63	
	64~71	
	72~79	
	80 - 94	GOBO1 Shake
	95 - 109	GOBO2 Shake
	110 - 124	GOBO3 Shake
	125 - 139	GOBO4 Shake
	140 - 154	GOBO5 Shake
	155 - 169	GOBO6 Shake
170 - 184	GOBO7 Shake	
185 - 199	GOBO8 Shake	
200 - 214	GOBO9 Shake	
215 - 235	Positive rainbow effect with increasing speed	
236 - 255	Negative rainbow effect with increasing speed	

DMX Channel Values (12 Channel for Wash)

CHANNEL	VALUE	FUNCTION
1	000 ↔ 255	Pan
2	000 ↔ 255	Pan Fine
3	000 ↔ 255	Tilt
4	000 ↔ 255	Tilt Fine
5	000 ↔ 255	Vector Speed:(Normal → Slow)
6		Dimmer/Strobe
	000 ↔ 007	Closed
	008 ↔ 134	100-0%
	135 ↔ 239	Strobe(slow → fast)
	240 ↔ 255	Open
7		Red
	000 ↔ 255	0-100%
8		Green
	000 ↔ 255	0-100%
9		Blue
	000 ↔ 255	0-100%
10		Color Macros
	000 ↔ 007	No Function
	008 ↔ 021	White
	022 ↔ 034	Red
	036 ↔ 049	Green
	050 ↔ 063	Blue
	064 ↔ 077	Cyan
	078 ↔ 091	Magenta
	092 ↔ 105	Yellow
	106 ↔ 119	Purple
	120 ↔ 133	Orange
	134 ↔ 147	Chartreuse
	148 ↔ 161	Pink
	162 ↔ 175	Brown
	176 ↔ 189	Gold
	190 ↔ 203	Crimson
204 ↔ 217	Violet	
218 ↔ 231	Crape	
232 ↔ 255	Color-Change Macro 1	
11	000 ↔ 255	Vector Speed(Color)
12		Movement Macros
	000 ↔ 007	No Function
	008 ↔ 022	Auto Program 1
	023 ↔ 037	Auto Program 2
	038 ↔ 052	Auto Program 3
	053 ↔ 067	Auto Program 4
	068 ↔ 082	Auto Program 5
	083 ↔ 097	Auto Program 6
	098 ↔ 112	Auto Program 7
	113 ↔ 127	Auto Program 8
	128 ↔ 142	Sound Active 1
	143 ↔ 157	Sound Active 2
	158 ↔ 172	Sound Active 3
	173 ↔ 187	Sound Active 4
	188 ↔ 202	Sound Active 5
	203 ↔ 217	Sound Active 6
218 ↔ 232	Sound Active 7	
233 ↔ 255	Sound Active 8	

DMX Channel Values (5 Channel for Spot)

CHANNEL	VALUE	FUNCTION
1	000 ↔ 255	Pan
2	000 ↔ 255	Tilt
3	000 ↔ 007	Dimmer/Strobe
	008 ↔ 134	Closed
	135 ↔ 239	100-0% Strobe(slow → fast)
	240 ↔ 255	Open
4		Color Macros
	000 ↔ 007	No Function
	008 ↔ 021	White
	022 ↔ 034	Red
	036 ↔ 049	Green
	050 ↔ 063	Blue
	064 ↔ 077	Cyan
	078 ↔ 091	Magenta
	092 ↔ 105	Yellow
	106 ↔ 119	Purple
	120 ↔ 133	Orange
	134 ↔ 147	Chartreuse
	148 ↔ 161	Pink
	162 ↔ 175	Brown
	176 ↔ 189	Gold
	190 ↔ 203	Crimson
	204 ↔ 217	Violet
218 ↔ 231	Crape	
232 ↔ 255	Color-Change Macro 1	
5		Gobo
		 0~7
		 8~15
		 16~23
		 24~31
		 32~39
		 40~47
		 48~55
		 56~63
		 64~71
		 72~79
		80 - 94
		95 - 109
		110 - 124
		125 - 139
		140 - 154
		155 - 169
		170 - 184
		185 - 199
	200 - 214	
	215 - 235	
	236 - 255	
	GOGO1 Shake(from slow to fast)	
	GOGO2 Shake(from slow to fast)	
	GOGO3 Shake(from slow to fast)	
	GOGO4 Shake(from slow to fast)	
	GOGO5 Shake(from slow to fast)	
	GOGO6 Shake(from slow to fast)	
	GOGO7 Shake(from slow to fast)	
	GOGO8 Shake(from slow to fast)	
	GOGO9 Shake(from slow to fast)	
	Positive rainbow effect with increasing speed	
	Negative rainbow effect with increasing speed	

DMX Channel Values (4 Channel for Wash)

CHANNEL	VALUE	FUNCTION
1	000 ↔ 255	Pan
2	000 ↔ 255	Tilt
3	000 ↔ 007	Dimmer/Strobe
	008 ↔ 134	Closed
	135 ↔ 239	100-0% Strobe(slow → fast)
	240 ↔ 255	Open
4		Color Macros
	000 ↔ 007	No Function
	008 ↔ 021	White
	022 ↔ 034	Red
	036 ↔ 049	Green
	050 ↔ 063	Blue
	064 ↔ 077	Cyan
	078 ↔ 091	Magenta
	092 ↔ 105	Yellow
	106 ↔ 119	Purple
	120 ↔ 133	Orange
	134 ↔ 147	Chartreuse
	148 ↔ 161	Pink
	162 ↔ 175	Brown
	176 ↔ 189	Gold
	190 ↔ 203	Crimson
	204 ↔ 217	Violet
218 ↔ 231	Crape	
232 ↔ 255	Color-Change Macro 1	

5. APPENDIX

Technical Specifications

WEIGHT & DIMENSIONS

Length.....	6.8 in (173 mm)
Width	6.8 in (173 mm)
Height	9.8 in (249 mm)
Weight	8.3 lbs (3.8 kg)

POWER

Switch-selectable power settings	120V 60Hz AC or 230V 50Hz
Fuse.....	2A 250V
Power Consumption	68.1W (0.60A) Max at 120V
Inrush Power	83.6W (1.41A) inrush at 120V
Power Factor	0.92

LIGHT SOURCE

LED.....	1, 14W RGB 50,000hrs
----------	----------------------

PHOTO OPTIC

Beam Angle	13°
Illuminance at 1M	100 fc (1,076 lux)

RANGE

Pan	540°
Tilt.....	270°

THERMAL

Maximum ambient temperature.....	104° F (40° C)
----------------------------------	----------------

CONTROL & PROGRAMMING

Data input	locking 3-pin XLR male socket
Data output	locking 3-pin XLR female socket
Data pin configuration	pin 1 shield, pin 2 (-), pin 3 (+)
Protocols.....	DMX-512 USITT
DMX Channels	5 or 13

ORDERING INFORMATION

Mini Spot/wash.....	spot/wash
Optional Controller	CA-9

WARRANTY INFORMATION

Warranty	2-year limited warranty
----------------	-------------------------